

# Data Sheet



Article number: 2302166161

Description: E+G Lobe knobs  
VC.692/25 SST-p-M5x10

## Measures

---

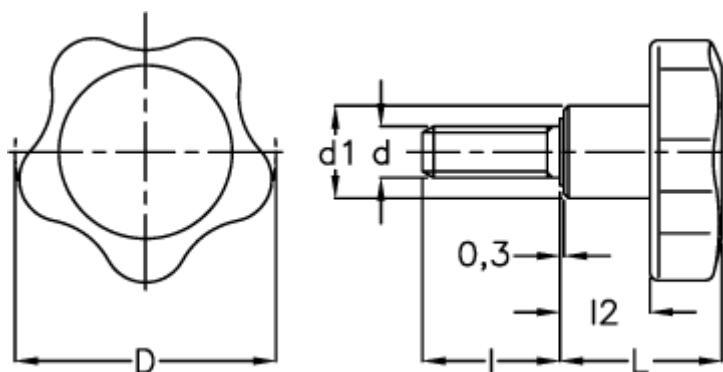

D	= 25
d1	= 12
d 6g	= M5
l	= 10
L	= 20
l2	= 10